

PART NO. 7804xxLA051
 DWG NO. C7804LA

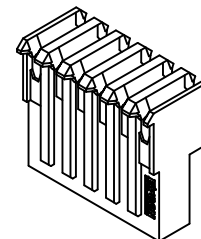
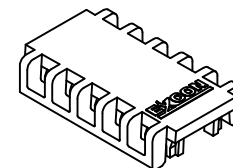
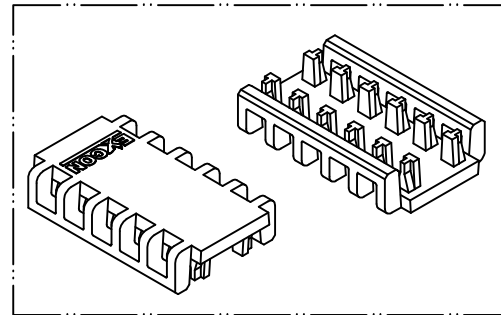
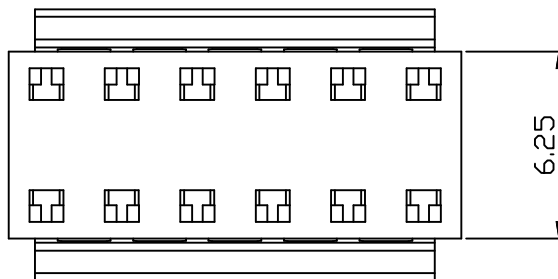
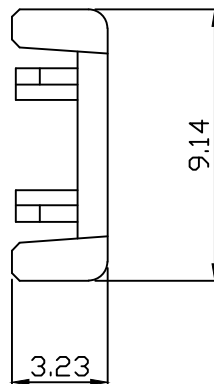
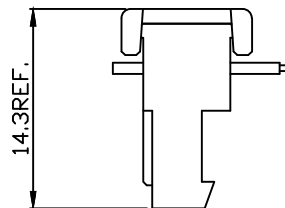
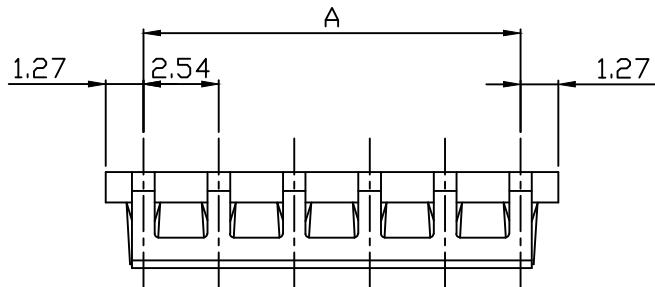

Dimensional & Ordering Information:

Part No.	Circuits	Dim A
780402LA051	2	2.54
780403LA051	3	5.08
780404LA051	4	7.62
780405LA051	5	10.16
780406LA051	6	12.70
780407LA051	7	15.24
780408LA051	8	17.78
780409LA051	9	20.32
780410LA051	10	22.86
780411LA051	11	25.40
780412LA051	12	27.94
780413LA051	13	30.48
780414LA051	14	33.02
780415LA051	15	35.56
780416LA051	16	38.10
780417LA051	17	40.64
780418LA051	18	43.18
780419LA051	19	45.72
780420LA051	20	48.26
780421LA051	21	50.80
780422LA051	22	53.34
780423LA051	23	55.88
780424LA051	24	58.42
780425LA051	25	60.96
780426LA051	26	63.50
780427LA051	27	66.04
780428LA051	28	68.58

NOTE:

- Housing Material: Nylon 66 UL94V2
- Color: Natural
- Withstand voltage: 1500V AC/minute.
- Current rating: 3A AC/DC.
- Voltage rating: 250V AC/DC

UNLESS OTHERWISE SPECIFIED TOLERANCES
 3 PLACE ±0.5 ±0.10
 2 PLACE ±1.5 ±0.25
 1 PLACE ±2.0 ±0.50
 ANGLE DIM

EXCON
 EXCON TECHNOLOGY COMPANY

REV.	REVISION	DIS	DATE
SCALE	REV.	PAGE	UNIT
5/1	A	1	mm

DWG NO: C7804LA

PART.NO: 7804xxLA051

