

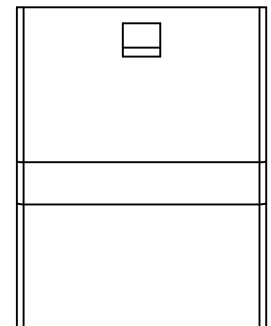

10 9 8 7 6 5 4 3 2 1

PART NO. 660903HF001
 DWG NO. C6609HF

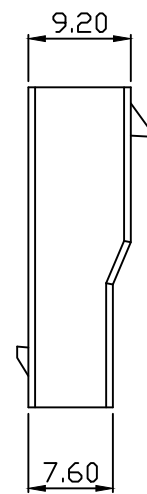
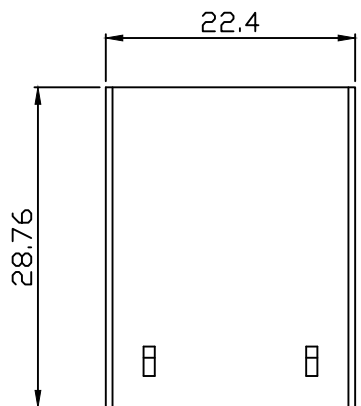
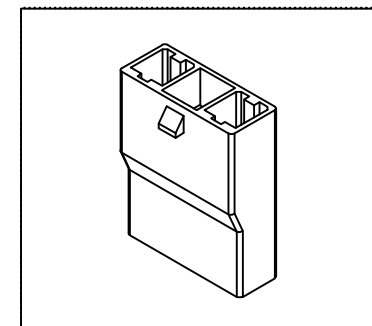
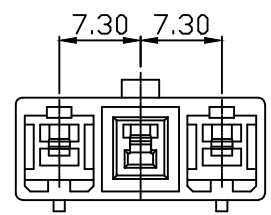

NOTE:

1. Housing Material: Nylon 66 UL 94V-0
2. Insulation resistance: 1000M ohm/min.
3. Withstand voltage: 300V AC/minute.
4. Current rating: 4A AC/DC.

				UNLESS OTHERWISE SPECIFIED TOLERANCES		 EXCON TECHNOLOGY COMPANY
				3 PLACE ±0.5 ±0.10		
				2 PLACE ±1.5 ±0.35		
				1 PLACE ±2.0 ±0.50		
				ANGLE DIM		
REV.	REVISION			DIS	DATE	
SCALE	REV.	PAGE	UNIT	mm		DWG NO:
5/1	A	1	THIRD ANGLE PROJECTION			C6609HF
					PART.NO	
					660903HF001	

10 9 8 7 6 5 4 3 2 1

E
D
C
B
A

F
E
D
C
B
A