

10 9 8 7 6 5 4 3 2 1

PART NO. 6608xxHM051
 DWG NO. C6608HM

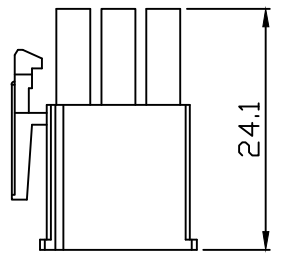
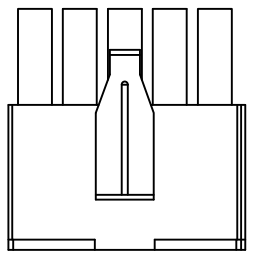
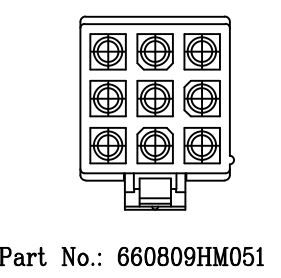
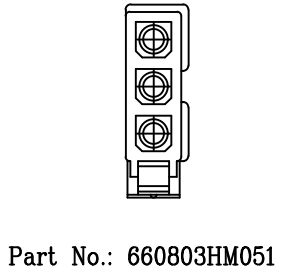
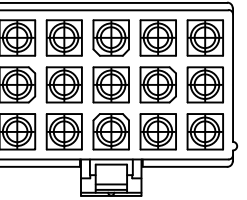
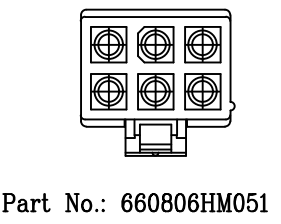
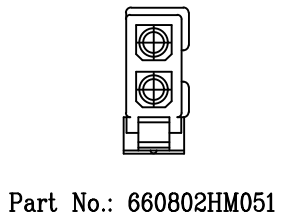
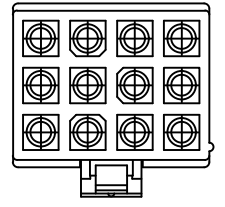
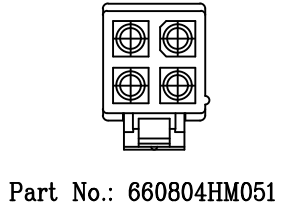
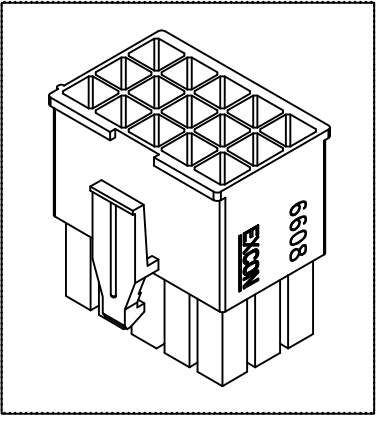
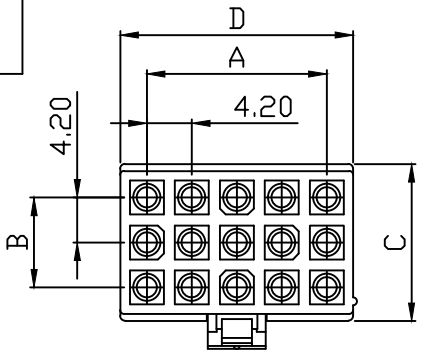

Dimensional & Ordering Information:

Part No.	Circuits	Dim A	Dim B	Dim C	Dim D
660801HM051	1	--	--	6.6	5.6
660802HM051	2	--	4.2	10.8	5.6
660803HM051	3	--	8.4	15.0	5.6
660804HM051	4	4.2	4.2	10.8	9.8
660806HM051	6	8.4	4.2	10.8	14.0
660809HM051	9	13.4	13.4	15.0	14.0
660812HM051	12	12.6	8.4	15.0	18.2
660815HM051	15	16.8	8.4	15.0	22.4

NOTE:

- Housing Material: Nylon 66 UL94V2 or V0
- Color: Natural
- Withstand voltage: 1500V AC/minute.
- Current rating: 5A AC/DC.
- Voltage rating: 600V AC/DC

UNLESS OTHERWISE SPECIFIED TOLERANCES
 3 PLACE ±0.5 ±0.10
 2 PLACE ±1.5 ±0.25
 1 PLACE ±2.0 ±0.50
 ANGLE DIM



REV.	REVISION	DIS	DATE	DWG NO:	PART.NO
NONE	B	1	THIRD ANGLE PROJECTION	C6608HM	6608xxHM051

A

B

C

D

E

F

A

B

C

D

E

F

10 9 8 7 6 5 4 3 2 1