

10 9 8 7 6 5 4 3 2 1

PART NO. 660600TP051  
 DWG NO. Q6606TP

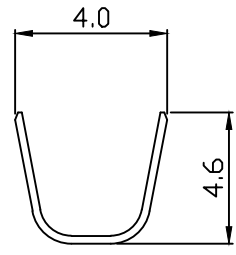

SEC A-A

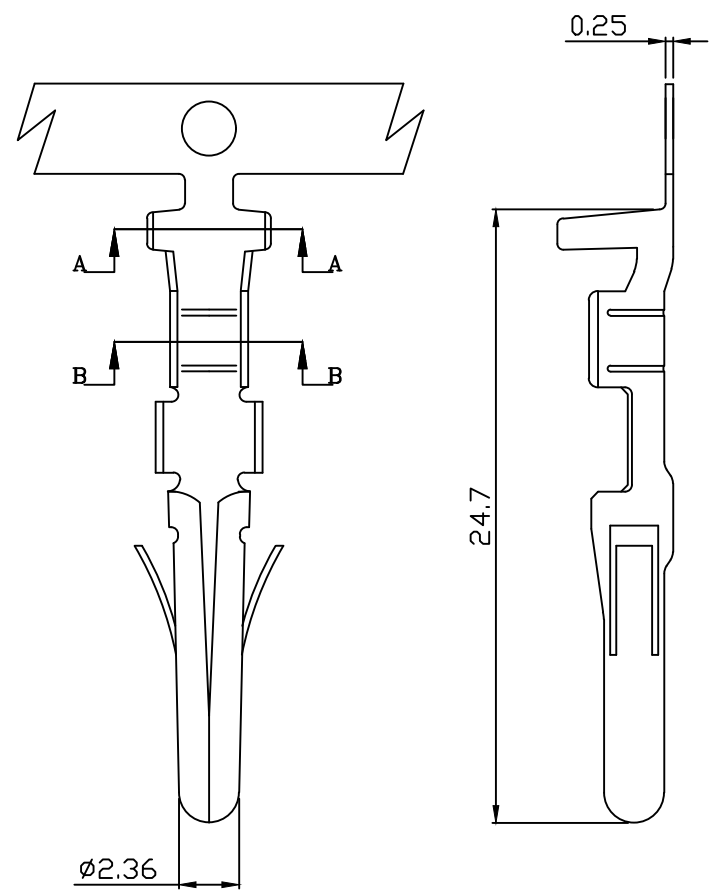
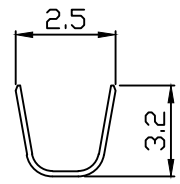



SEC B-B

**NOTE:**

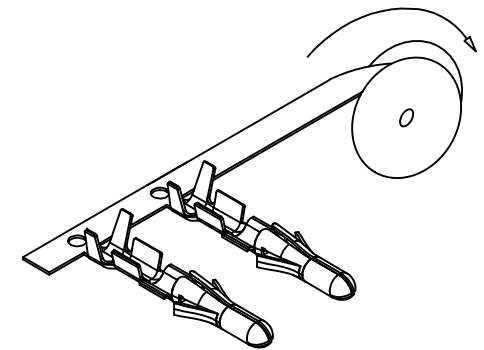
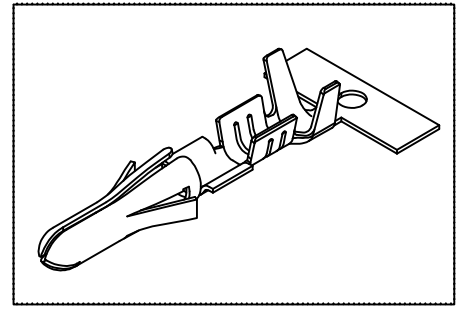
1. Terminal Material: Brass bronze
2. Plated: Ni 25u"min Tin-plated 50u"min.
3. Insulation O.D.: 1.4~2.1mm
4. Applicable wires: #24~#18
5. Q'ty / reel: 4,000pcs



				UNLESS OTHERWISE SPECIFIED TOLERANCES		 <b>EXCON TECHNOLOGY COMPANY</b>
				3 PLACE ±0.5 ±0.10		
				2 PLACE ±1.5 ±0.25		
				1 PLACE ±2.0 ±0.50		PART.NO
				ANGLE DIM		
REV.	REVISIONI			DIS	DATE	DWG NO:
SCALE	REV.	PAGE:	UNIT	mm		
NONE	B	1	THIRD ANGLE PROJECTION			Q6606TP
						660600TP051

10 9 8 7 6 5 4 3 2 1