

10 9 8 7 6 5 4 3 2 1

PART NO. 660100TAxxx
 DWG NO. C6601TA

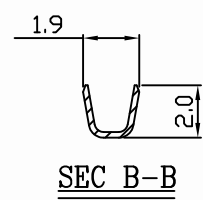
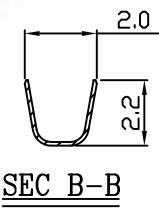
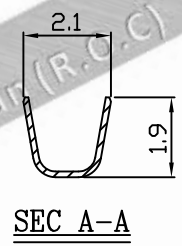
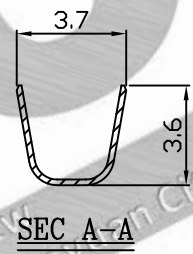
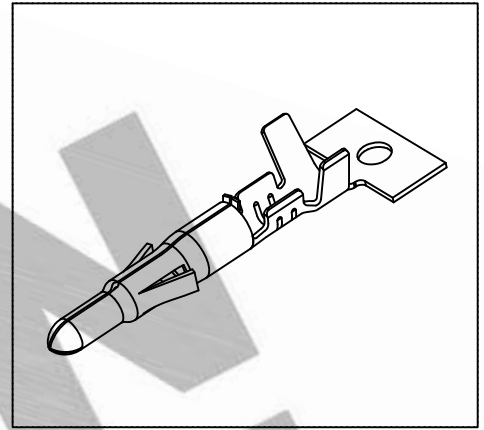
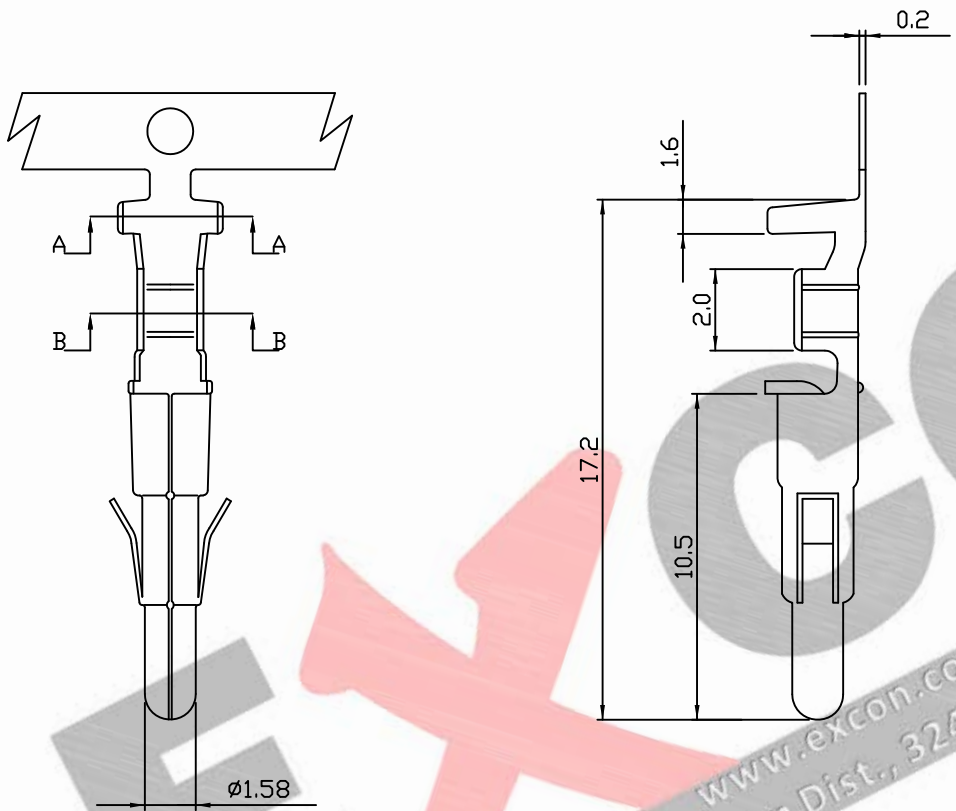

660100TA051
 660100TA351

660100TP051
 660100TP351

NOTE 1 :

1. Terminal Material: Brass ,phospor bronze
2. Plated: Ni 25u"min Tin-plated 50u"min.
3. Applicable wires: #26~#20
4. Q'ty / reel: 7,000 pcs

				UNLESS OTHERWISE SPECIFIED TOLERANCES		 EXCON EXCON TECHNOLOGY COMPANY
				3 PLACE ±0.5 ±0.10		
				2 PLACE ±1.5 ±0.35		
				1 PLACE ±2.0 ±0.50		
				ANGLE DIM		
REV.	REVISIONI			DIS	DATE	
SCALE	REV.	PAGE:	UNIT	mm		DWG NO:
4/1	A	1	THIRD ANGLE PROJECTION			C6601TA
					PART.NO	
					660100TAxxx	

10 9 8 7 6 5 4 3 2 1