

PART NO. 508900TCxxx
 DWG NO. C5089TC

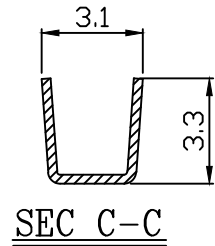
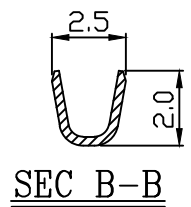
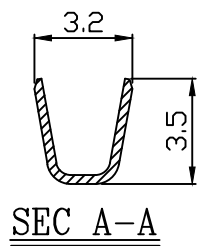
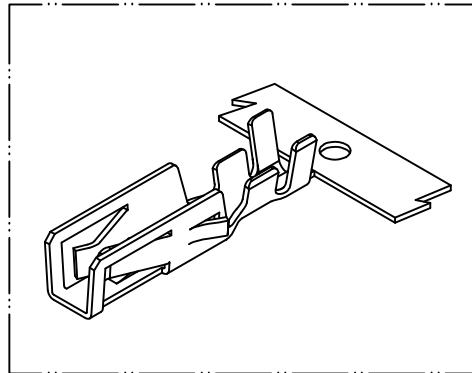
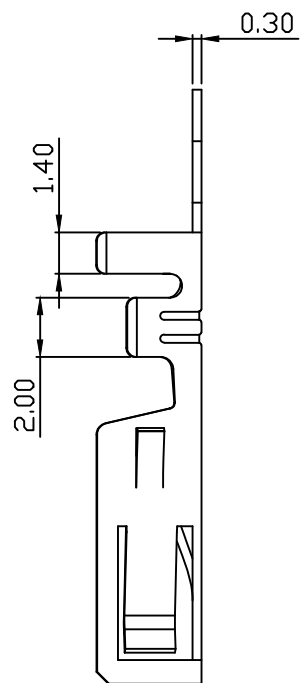
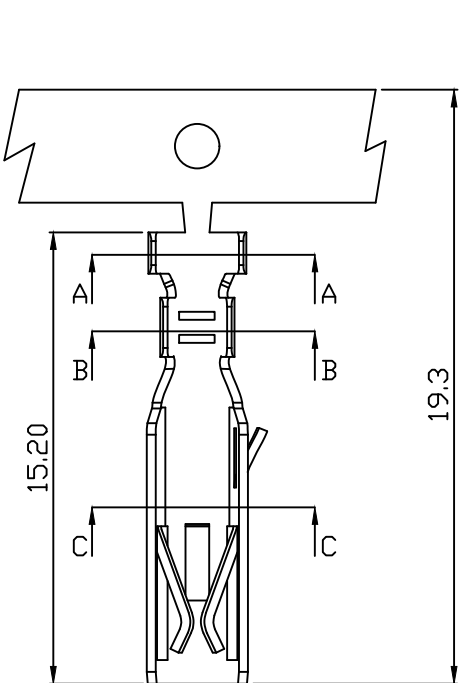

NOTE:

1. Terminal Material: Phosphor or Brass bronze
2. Plated: Tin pre-plated 50u"min.
3. Applicable wires: AWG#18-#24
4. Insulation O.D.: 1.3-2.8mm
5. Q'ty / reel:6,000 pcs

Part No.	Wire Range	Insulation O.D.	Material	Finishing	Q'ty/reel
508900TC051	AWG#26~#18	1.3-2.8mm	Brass	Tin pre-plated	6,000pcs
508900TC351	AWG#26~#18	1.3-2.8mm	Phosphor	Tin pre-plated	6,000pcs
UNLESS OTHERWISE SPECIFIED TOLERANCES					EXCON EXCON TECHNOLOGY COMPANY
3 PLACE ±0.5 ±0.10					
2 PLACE ±1.5 ±0.25					
1 PLACE ±2.0 ±0.50					
REV.	REVISION		DIS	DATE	ANGLE DIM
SCALE	REV.	PAGE:	UNIT	mm	DWG NO:
5/1	B	1	THIRD ANGLE PROJECTION		C5089TC
					PART.NO
					508900TCxxx