

PART NO. 508400TC051  
 DWG NO. C5084TC

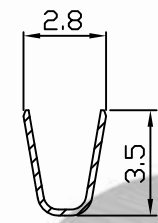

SEC A-A

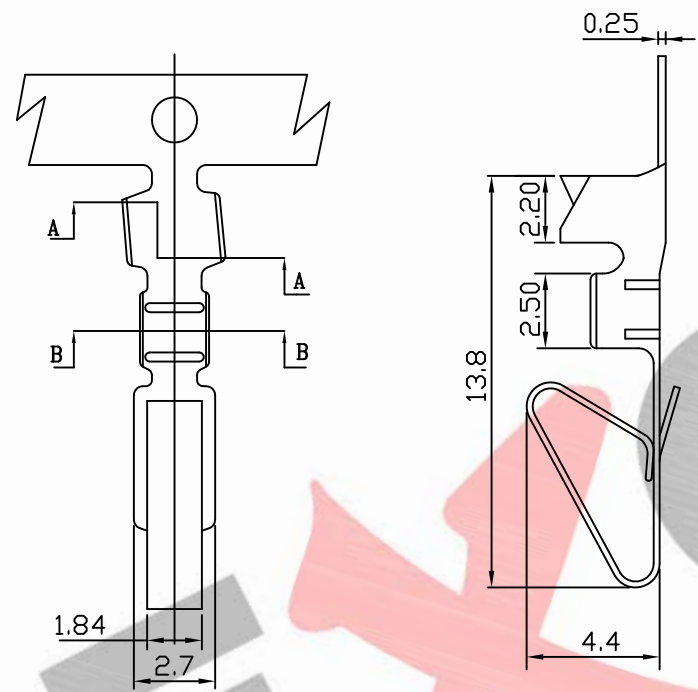
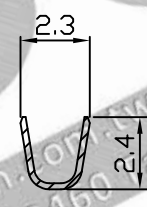

SEC B-B

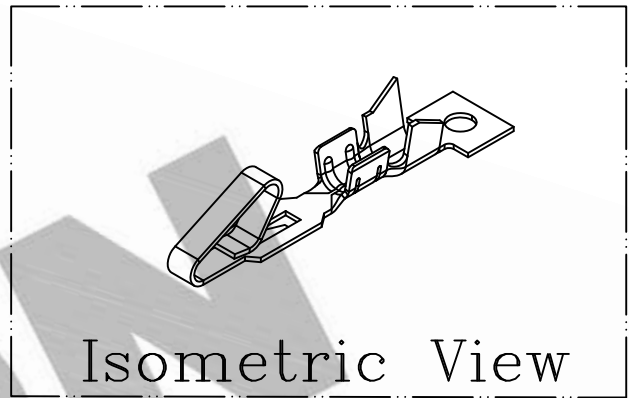

Isometric View

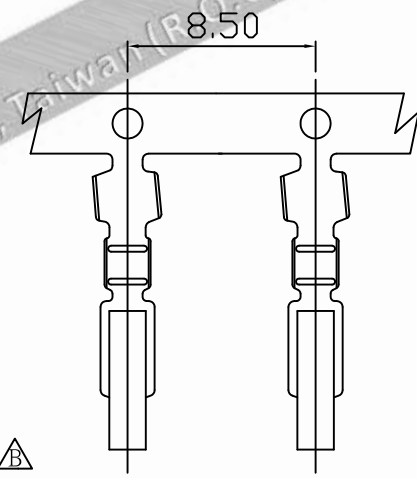

( 5 : 1 )

NOTE:

1. Terminal Material: Brass bronze
2. Plated: Tin pre-plated 50u"min.
3. Current rating: 5A AC/DC
4. Voltage rating: 250V AC/DC
5. Withstand voltage: 1000V AC/minute
6. Insulation resistance:1000MΩ min
7. Applicable wires: AWG#18-#24
8. Insulation O.D.: 1.2~2.8mm
9. Q'ty / reel: 6,000pcs

D		變更	△	Christy	3/7 2016	UNLESS OTHERWISE SPECIFIED TOLERANCES 3 PLACE ±0.5 ±0.10 2 PLACE ±1.5 ±0.25 1 PLACE ±2.0 ±0.50 ANGLE DIM
C		NOTE: 修改 第 2 項 Tin-Plated → Tin pre-Plated 新增 第 3、4、5、6 項	△	Christy	5/28 2015	
REV.	REVISIONI			DIS	DATE	
SCALE	REV.	PAGE:	UNIT		mm	DWG NO:
8/1	D	1/1	THIRD ANGLE PROJECTION		⊕	C5084TC

**EXCON**  
 EXCON TECHNOLOGY COMPANY

PART.NO  
 508400TC051