

10 9 8 7 6 5 4 3 2 1

PART NO. 420200TY051  
 DWG NO. C4202TY

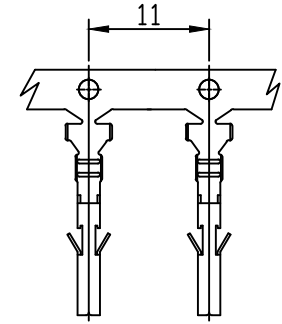
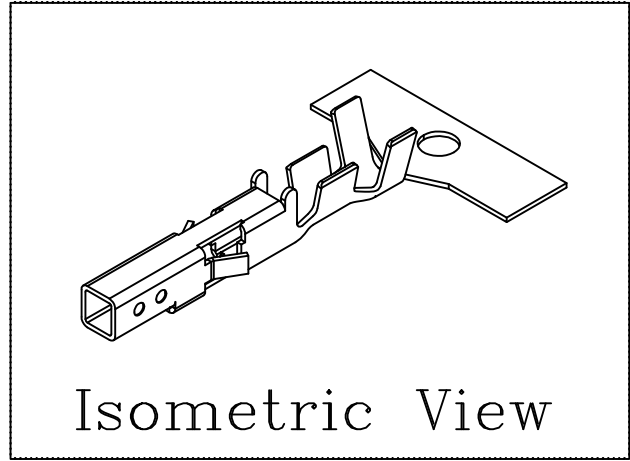
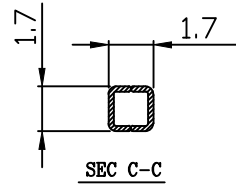
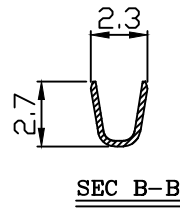
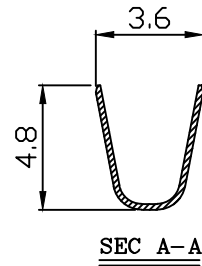
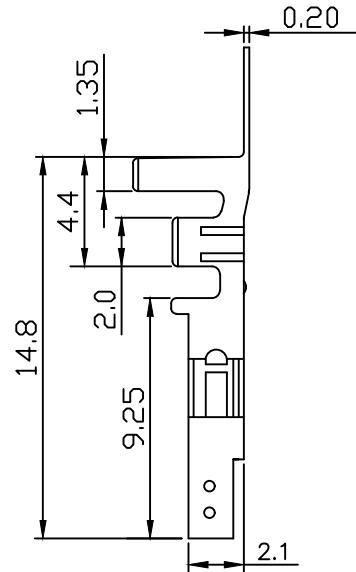
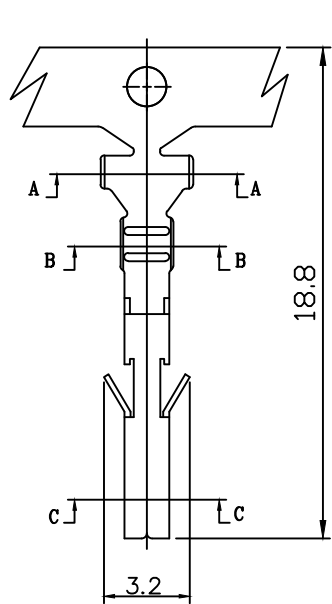

NOTE:

1. Terminal Material: Brass bronze or Phosphor bronze
2. Plated: Tin pre-plated 50u"min.
3. Current rating: 5A AC/DC
4. Voltage rating: 600V AC/DC
5. Withstand voltage: 1500V AC/minute
6. Insulation resistance: 1000MΩ min
7. Insulation O.D.: 1.7~2.8mm
8. Q'ty / reel: 4,000pcs

No.	Part No.	Wire Range	Material	Finishing
1	420200TY051	AWG#16~#20	Brass	Tin pre-plated
2	420200TY351	AWG#16~#20	Phosphor	Tin pre-plated

C		DWG RELEASE		Christy	1/7 2016	UNLESS OTHERWISE SPECIFIED TOLERANCES 3 PLACE ±0.5 ±0.10 2 PLACE ±1.5 ±0.25 1 PLACE ±2.0 ±0.50 ANGLE DIM	<b>EXCON</b> EXCON TECHNOLOGY COMPANY
REV.	REVISIONI			DIS	DATE		
SCALE	REV.	PAGE:	UNIT	mm		DWG NO:	PART.NO
4/1	C	1/1	THIRD ANGLE	PROJECTION		C4201TY	420200TYx51

10 9 8 7 6 5 4 3 2 1