

PART NO. 3002xxHM003
 DWG NO. C3002HM

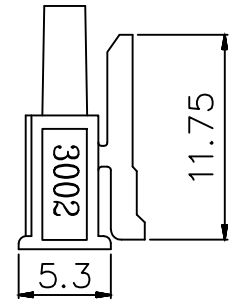
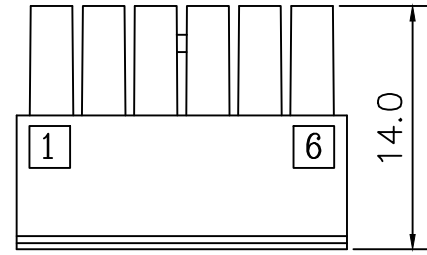
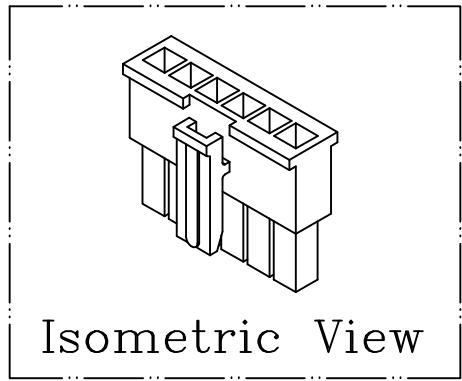
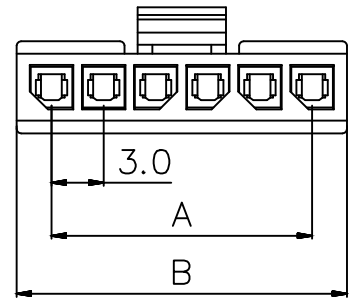

Ordering Information and Dimensions:

Part No.	Circuits	Dim A	Dim B
300202HM003	2	3.0	6.85
300203HM003	3	6.0	9.85
300204HM003	4	9.0	12.85
300205HM003	5	12.0	15.85
300206HM003	6	15.0	18.85
300207HM003	7	18.0	21.85
300208HM003	8	21.0	24.85
300209HM003	9	24.0	27.85
300210HM003	10	27.0	30.85
300211HM003	11	30.0	33.85
300212HM003	12	33.0	36.85

NOTE:

1. Housing Material: NY66 UL 94V0
2. Current rating: 5A AC/DC.
3. Voltage rating: 250V AC/DC
4. Insulation resistance: 1000MΩ min.
5. Withstand voltage: 1500V AC/minute.
6. Color : Black

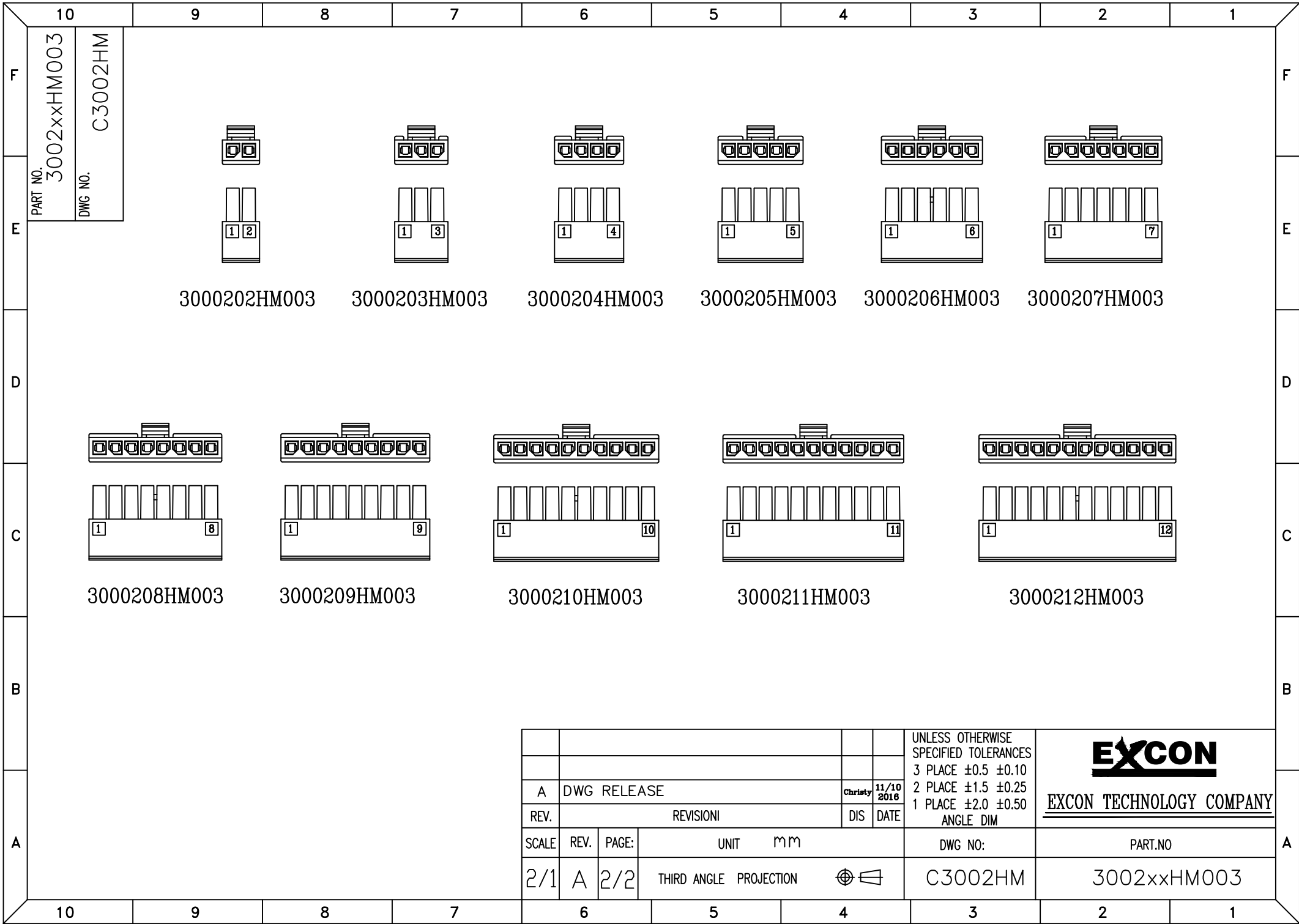

				UNLESS OTHERWISE SPECIFIED TOLERANCES		 EXCON TECHNOLOGY COMPANY	
				3 PLACE ±0.5 ±0.10			
A DWG RELEASE				Christy	11/10		
REV. REVISIONI				DIS	DATE		
SCALE	REV.	PAGE:	UNIT	mm		DWG NO:	PART.NO
2/1	A	1/2	THIRD ANGLE PROJECTION			C3002HM	3002xxHM003



PART NO.
3002xxHM003
DWG NO.
C3002HM

3000202HM003 3000203HM003 3000204HM003 3000205HM003 3000206HM003 3000207HM003

3000208HM003 3000209HM003 3000210HM003 3000211HM003 3000212HM003

				UNLESS OTHERWISE SPECIFIED TOLERANCES		 EXCON TECHNOLOGY COMPANY
				3 PLACE ±0.5 ±0.10		
				2 PLACE ±1.5 ±0.25		
				1 PLACE ±2.0 ±0.50		
REV.	REVISION			DIS	DATE	
A	DWG RELEASE			Christy	11/10 2016	
SCALE	REV.	PAGE:	UNIT	mm		DWG NO:
2/1	A	2/2	THIRD ANGLE	PROJECTION		C3002HM
						PART.NO
						3002xxHM003