

PART NO. 3001xxHP003
 DWG NO. C3001HP

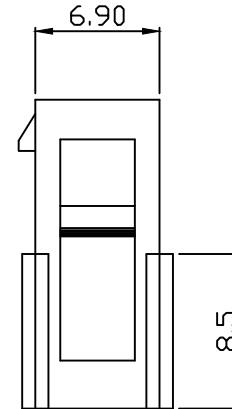
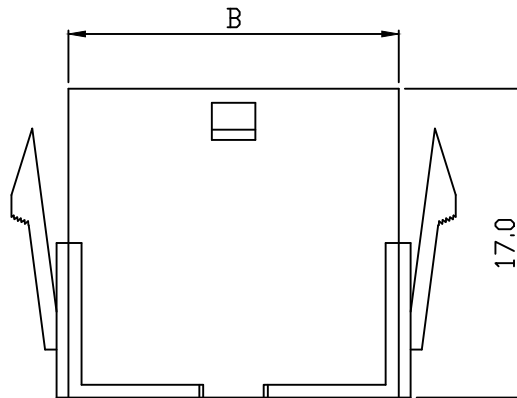
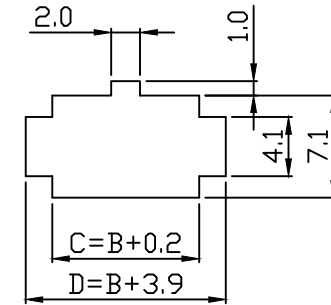
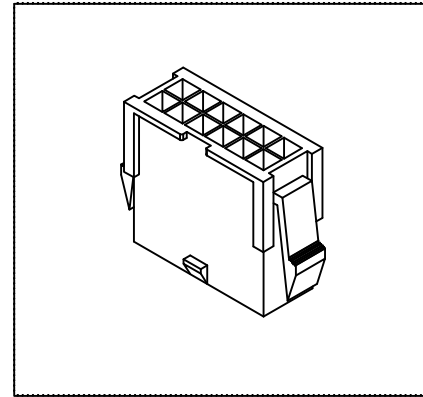
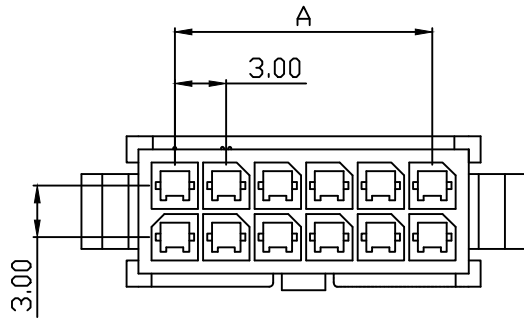

Panel layout

Dimensional & Ordering Information:

Part No.	Circuits	Dim A	Dim B
300102HP003	2	--	4.0
300104HP003	4	3.0	7.0
300106HP003	6	6.0	10.0
300108HP003	8	9.0	13.0
300110HP003	10	12.0	16.0
300112HP003	12	15.0	19.0
300114HP003	14	18.0	22.0
300116HP003	16	21.0	25.0
300118HP003	18	24.0	28.0
300120HP003	20	27.0	31.0
300122HP003	22	30.0	34.0
300124HP003	24	33.0	37.0

NOTE:

1. Housing Material: Nylon 66 UL94V0
2. Color: Black
3. Withstand voltage: 1500V AC/minute.
4. Current rating: 5A AC/DC.
5. Voltage rating: 250V AC/DC

REV.	REVISION	DIS	DATE

UNLESS OTHERWISE SPECIFIED TOLERANCES
 3 PLACE ±0.5 ±0.10
 2 PLACE ±1.5 ±0.25
 1 PLACE ±2.0 ±0.50
 ANGLE DIM



SCALE	REV.	PAGE	UNIT	mm
4/1	A	1/2	THIRD ANGLE PROJECTION	

DWG NO: C3001HP

PART.NO: 3001xxHP003

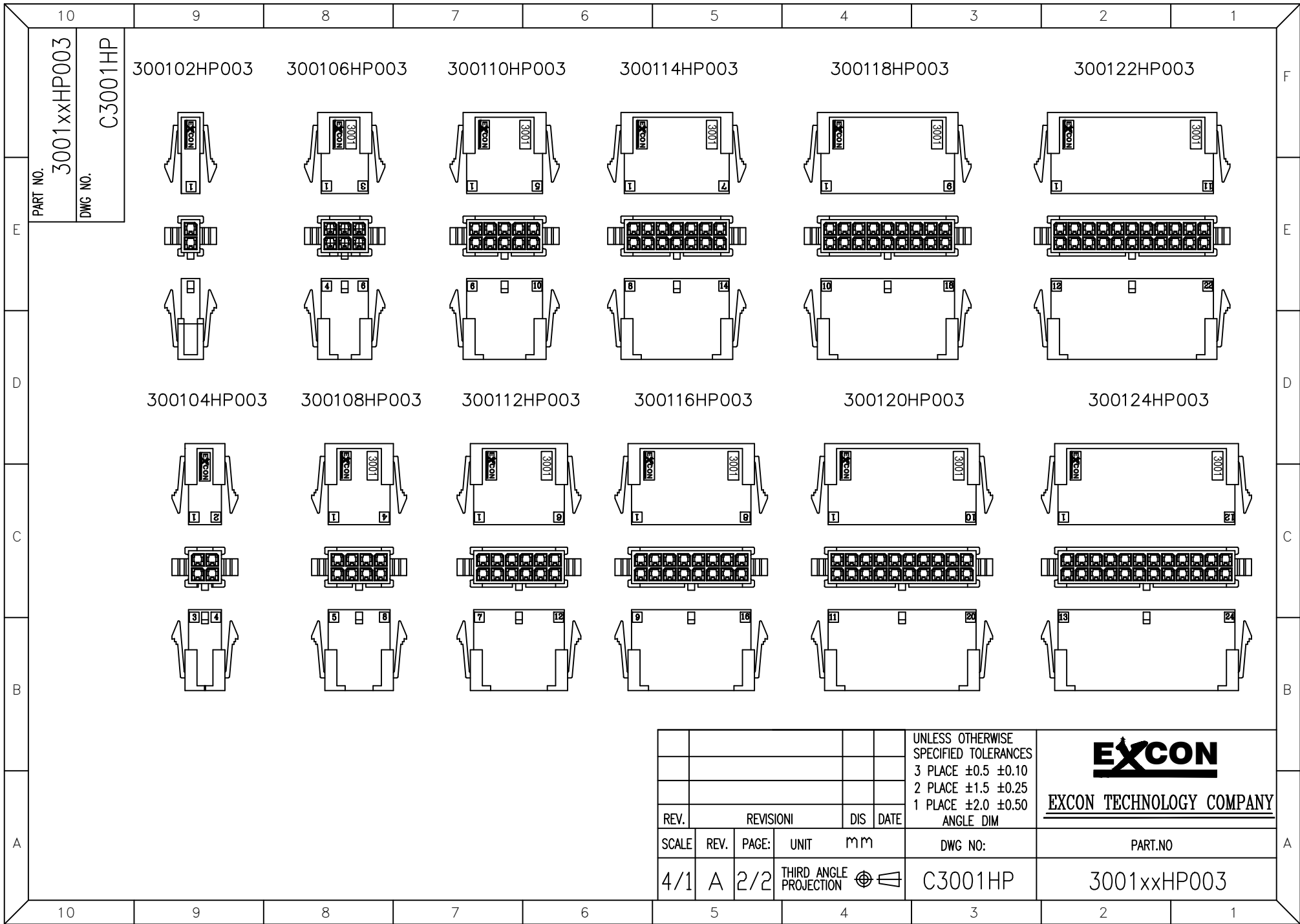

PART NO. 3001xxHP003
 DWG NO. C3001HP

300102HP003

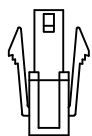
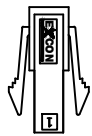

300106HP003

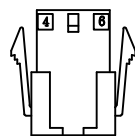
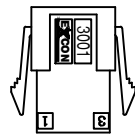

300110HP003

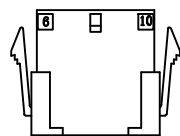
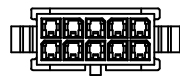
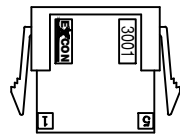

300114HP003

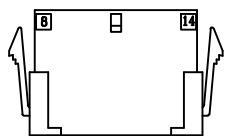
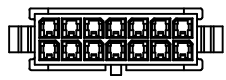
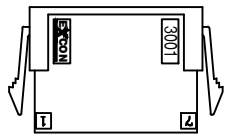

300118HP003

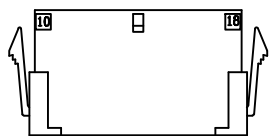
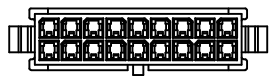
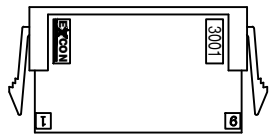

300122HP003

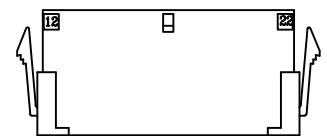
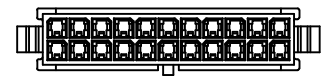
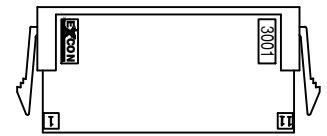

300104HP003

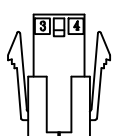
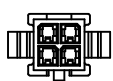
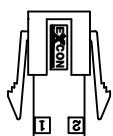

300108HP003

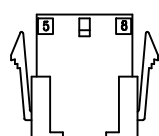
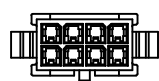
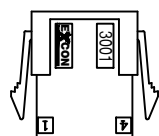

300112HP003

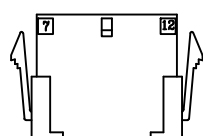
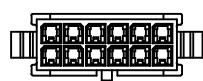
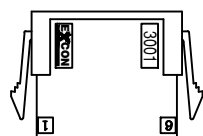

300116HP003

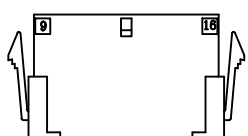
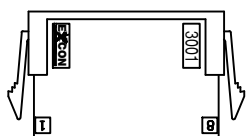

300120HP003

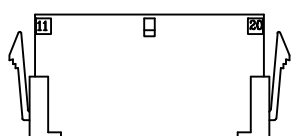

300124HP003

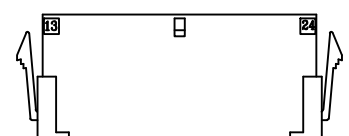
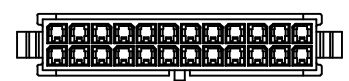

				UNLESS OTHERWISE SPECIFIED TOLERANCES		 EXCON TECHNOLOGY COMPANY
				3 PLACE ±0.5 ±0.10		
				2 PLACE ±1.5 ±0.25		PART.NO
				1 PLACE ±2.0 ±0.50		
				ANGLE DIM		3001xxHP003
REV.	REVISIONI		DIS	DATE		
SCALE	REV.	PAGE:	UNIT	mm	DWG NO:	
4/1	A	2/2	THIRD ANGLE PROJECTION		C3001HP	