

PART NO. 250900TRxx1  
 DWG NO. C2509TR

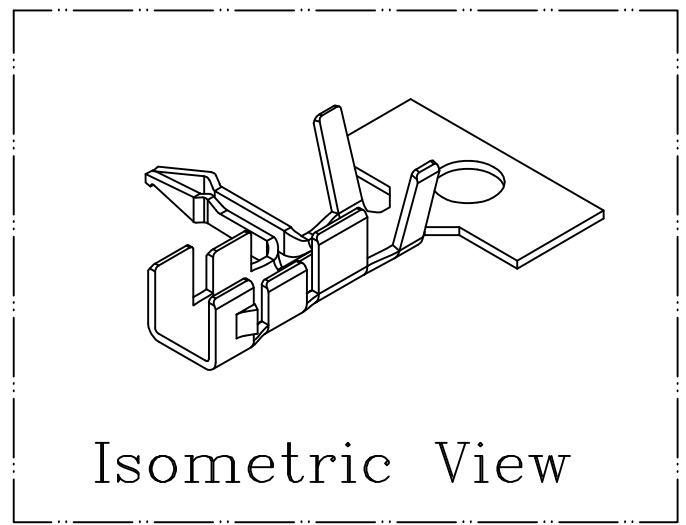
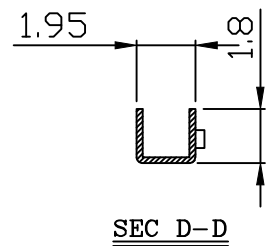
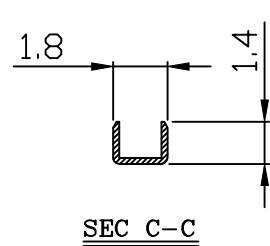
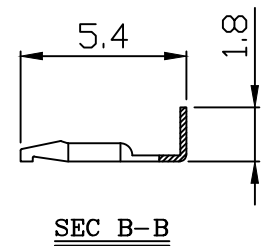
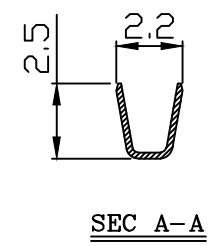
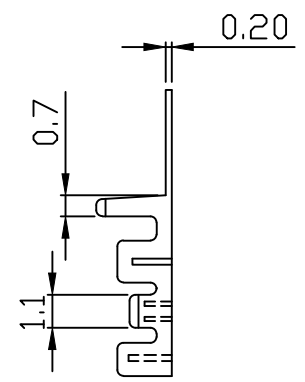
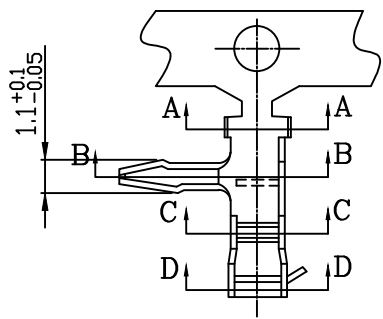

NOTE:

1. Terminal Material: Brass bronze or Phosphor bronze
2. Plated: Tin pre-plated or Tin-plated 50u"min.
3. Current rating: 2.5A AC/DC
4. Voltage rating: 250V AC/DC
5. Withstand voltage: 800V AC/minute
6. Insulation resistance:1000MΩ
7. Applicable wires: AWG#28-#22
8. Insulation O.D.: 1.2-1.9mm
9. Q'ty / reel:10,000pcs

Ordering Information and Dimensions:

Part No.	Material	Finishing
250900TR001	Brass	Tin plated
250900TR051		Tin pre-plated

UNLESS OTHERWISE SPECIFIED TOLERANCES  
 3 PLACE ±0.5 ±0.10  
 2 PLACE ±1.5 ±0.25  
 1 PLACE ±2.0 ±0.50  
 ANGLE DIM



REV.	REVISION		DIS	DATE
SCALE	REV.	PAGE:	UNIT mm	
5/1	D	1/1	THIRD ANGLE PROJECTION	

DWG NO:	PART.NO
C2509TR	250900TRxx1