

10 9 8 7 6 5 4 3 2 1

PART NO. 200200TR001
 DWG NO. C2002TR

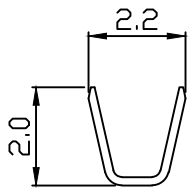

SEC A-A

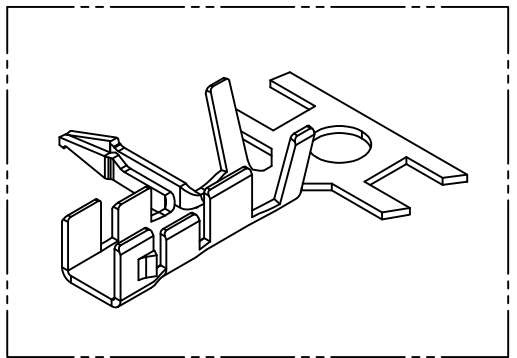
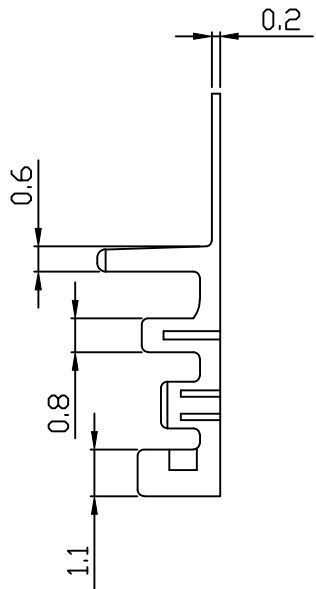
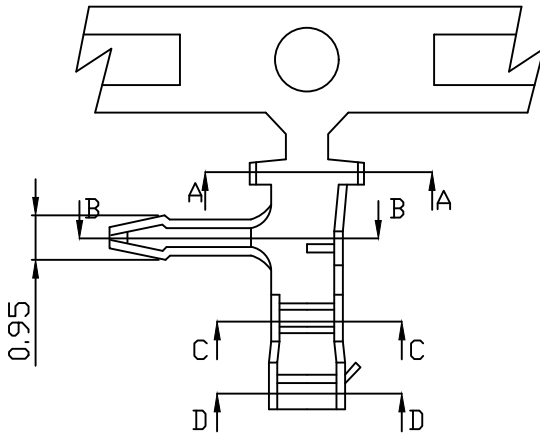
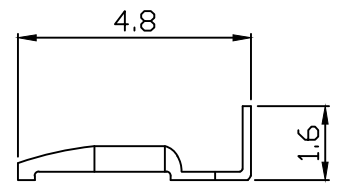

SEC B-B

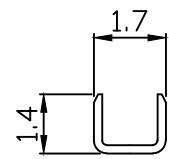

SEC C-C

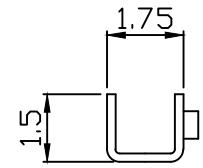

SEC D-D

NOTE:

1. Terminal Material: Phosphor or Brass bronze
2. Plated: Pre-stampt, Tin-plated
3. Applicable wires: AWG#30-#24
4. Insulation O.D.: 0.9-1.4mm
5. Q'ty / reel: 10,000 pcs

Part No.	Material	Finishing
200200TR001	Brass	Tin plated
200200TR051		Tin Pre-plated
200200TR301	Phosphor	Tin plated
200200TR351		Tin Pre-plated

UNLESS OTHERWISE SPECIFIED TOLERANCES
 3 PLACE ±0.5 ±0.10
 2 PLACE ±1.5 ±0.35
 1 PLACE ±2.0 ±0.50
 ANGLE DIM



REV.	REVISION	DIS	DATE

SCALE	REV.	PAGE:	UNIT	mm	DWG NO:	PART.NO
5/1	A	1	THIRD ANGLE PROJECTION		C2002TR	200200TR001

10 9 8 7 6 5 4 3 2 1